



TG/325/1

ORIGINAL: English

DATE: 2018-09-20

# INTERNATIONAL UNION FOR THE PROTECTION OF NEW VARIETIES OF PLANTS

Geneva

|   |
|---|
| <p><b>GREVILLEA</b></p> <p>UPOV Code(s):</p> <p>GREVI</p> <p><i>Grevillea</i> R. Br. corr. R. Br.</p> |
|---|

## GUIDELINES

### FOR THE CONDUCT OF TESTS

### FOR DISTINCTNESS, UNIFORMITY AND STABILITY

Alternative names:\*

| <i>Botanical name</i>   | <i>English</i> | <i>French</i> | <i>German</i> | <i>Spanish</i> |
|---|----------------|---------------|---------------|----------------|
| <i>Grevillea</i> R. Br. corr. R. Br., <i>Grevillea</i> hybrid, <i>Grevillea</i> R. Br | Grevillea      | Grevillea     | Grevillea     | Grevillea      |

The purpose of these guidelines ("Test Guidelines") is to elaborate the principles contained in the General Introduction (document TG/1/3), and its associated TGP documents, into detailed practical guidance for the harmonized examination of distinctness, uniformity and stability (DUS) and, in particular, to identify appropriate characteristics for the examination of DUS and production of harmonized variety descriptions.

## ASSOCIATED DOCUMENTS

These Test Guidelines should be read in conjunction with the General Introduction and its associated TGP documents.

\* These names were correct at the time of the introduction of these Test Guidelines but may be revised or updated. [Readers are advised to consult the UPOV Code, which can be found on the UPOV Website ([www.upov.int](http://www.upov.int)), for the latest information.]

| TABLE OF CONTENTS  | PAGE      |
|--|-----------|
| 1. SUBJECT OF THESE TEST GUIDELINES.....   | <u>3</u>  |
| 2. MATERIAL REQUIRED.....  | <u>3</u>  |
| 3. METHOD OF EXAMINATION.....  | <u>3</u>  |
| 3.1 Number of Growing Cycles.....  | <u>3</u>  |
| 3.2 Testing Place.....   | <u>3</u>  |
| 3.3 Conditions for Conducting the Examination.....   | <u>3</u>  |
| 3.4 Test Design.....   | <u>3</u>  |
| 3.5 Additional Tests.....  | <u>3</u>  |
| 4. ASSESSMENT OF DISTINCTNESS, UNIFORMITY AND STABILITY.....                                   | <u>4</u>  |
| 4.1 Distinctness.....  | <u>4</u>  |
| 4.2 Uniformity.....  | <u>5</u>  |
| 4.3 Stability.....   | <u>5</u>  |
| 5. GROUPING OF VARIETIES AND ORGANIZATION OF THE GROWING TRIAL.....                            | <u>5</u>  |
| 6. INTRODUCTION TO THE TABLE OF CHARACTERISTICS.....   | <u>6</u>  |
| 6.1 Categories of Characteristics.....   | <u>6</u>  |
| 6.2 States of Expression and Corresponding Notes.....  | <u>6</u>  |
| 6.3 Types of Expression.....   | <u>6</u>  |
| 6.4 Example Varieties.....   | <u>6</u>  |
| 6.5 Legend.....  | <u>7</u>  |
| 7. TABLE OF CHARACTERISTICS/TABLEAU DES CARACTÈRES/MERKMALSTABELLE/TABLA DE<br>CARACTERES..... | <u>8</u>  |
| 8. EXPLANATIONS ON THE TABLE OF CHARACTERISTICS.....   | <u>20</u> |
| 8.1 Explanations covering several characteristics.....   | <u>20</u> |
| 8.2 Explanations for individual characteristics.....   | <u>20</u> |
| 9. LITERATURE.....   | <u>30</u> |
| 10. TECHNICAL QUESTIONNAIRE.....   | <u>31</u> |

1. Subject of these Test Guidelines

These Test Guidelines apply to all varieties of *Grevillea* R. Br. corr. R. Br..

2. Material Required

2.1 The competent authorities decide on the quantity and quality of the plant material required for testing the variety and when and where it is to be delivered. Applicants submitting material from a State other than that in which the testing takes place must ensure that all customs formalities and phytosanitary requirements are complied with.

2.2 The material is to be supplied in the form of plants expressing relevant characteristics of the variety in the first growing cycle.

2.3 The minimum quantity of plant material, to be supplied by the applicant, should be:

10 plants.

2.4 The plant material supplied should be visibly healthy, not lacking in vigor, nor affected by any important pest or disease.

2.5 The plant material should not have undergone any treatment which would affect the expression of the characteristics of the variety, unless the competent authorities allow or request such treatment. If it has been treated, full details of the treatment must be given.

3. Method of Examination

3.1 *Number of Growing Cycles*

The minimum duration of tests should normally be a single growing cycle.

3.2 *Testing Place*

Tests are normally conducted at one place. In the case of tests conducted at more than one place, guidance is provided in TGP/9 "Examining Distinctness".

3.3 *Conditions for Conducting the Examination*

The tests should be carried out under conditions ensuring satisfactory growth for the expression of the relevant characteristics of the variety and for the conduct of the examination.

3.4 *Test Design*

3.4.1 Each test should be designed to result in a total of at least 10 plants.

3.4.2 The design of the tests should be such that plants or parts of plants may be removed for measurement or counting without prejudice to the observations which must be made up to the end of the growing cycle.

3.5 *Additional Tests*

Additional tests, for examining relevant characteristics, may be established.

#### 4. Assessment of Distinctness, Uniformity and Stability

##### 4.1 *Distinctness*

###### 4.1.1 General Recommendations

It is of particular importance for users of these Test Guidelines to consult the General Introduction prior to making decisions regarding distinctness. However, the following points are provided for elaboration or emphasis in these Test Guidelines.

###### 4.1.2 Consistent Differences

The differences observed between varieties may be so clear that more than one growing cycle is not necessary. In addition, in some circumstances, the influence of the environment is not such that more than a single growing cycle is required to provide assurance that the differences observed between varieties are sufficiently consistent. One means of ensuring that a difference in a characteristic, observed in a growing trial, is sufficiently consistent is to examine the characteristic in at least two independent growing cycles.

###### 4.1.3 Clear Differences

Determining whether a difference between two varieties is clear depends on many factors, and should consider, in particular, the type of expression of the characteristic being examined, i.e. whether it is expressed in a qualitative, quantitative, or pseudo-qualitative manner. Therefore, it is important that users of these Test Guidelines are familiar with the recommendations contained in the General Introduction prior to making decisions regarding distinctness.

###### 4.1.4 Number of Plants or Parts of Plants to be Examined

Unless otherwise indicated, for the purposes of distinctness, all observations on single plants should be made on 9 plants or parts of plants taken from each of 9 plants and any other observations made on all plants in the test, disregarding any off-type plants.

###### 4.1.5 Method of Observation

The recommended method of observing the characteristic for the purposes of distinctness is indicated by the following key in the Table of Characteristics (see document TGP/9 "Examining Distinctness", Section 4 "Observation of characteristics"):

MG: single measurement of a group of plants or parts of plants

MS: measurement of a number of individual plants or parts of plants

VG: visual assessment by a single observation of a group of plants or parts of plants

VS: visual assessment by observation of individual plants or parts of plants

Type of observation: visual (V) or measurement (M)

"Visual" observation (V) is an observation made on the basis of the expert's judgment. For the purposes of this document, "visual" observation refers to the sensory observations of the experts and, therefore, also includes smell, taste and touch. Visual observation includes observations where the expert uses reference points (e.g. diagrams, example varieties, side-by-side comparison) or non-linear charts (e.g. color charts). Measurement (M) is an objective observation against a calibrated, linear scale e.g. using a ruler, weighing scales, colorimeter, dates, counts, etc.

Type of record: for a group of plants (G) or for single, individual plants (S)

For the purposes of distinctness, observations may be recorded as a single record for a group of plants or parts of plants (G), or may be recorded as records for a number of single, individual plants or parts of plants (S). In most cases, "G" provides a single record per variety and it is not possible or necessary to apply statistical methods in a plant-by-plant analysis for the assessment of distinctness.

In cases where more than one method of observing the characteristic is indicated in the Table of Characteristics (e.g. VG/MG), guidance on selecting an appropriate method is provided in document TGP/9, Section 4.2.

#### 4.2 *Uniformity*

4.2.1 It is of particular importance for users of these Test Guidelines to consult the General Introduction prior to making decisions regarding uniformity. However, the following points are provided for elaboration or emphasis in these Test Guidelines:

4.2.2 These Test Guidelines have been developed for the examination of vegetatively propagated varieties. For varieties with other types of propagation the recommendations in the General Introduction and document TGP/13 "Guidance for new types and species", Section 4.5 "Testing Uniformity" should be followed.

4.2.3 For the assessment of uniformity of vegetatively propagated varieties, a population standard of 1% and an acceptance probability of at least 95% should be applied. In the case of a sample size of 10 plants, 1 off-type is allowed.

#### 4.3 *Stability*

4.3.1 In practice, it is not usual to perform tests of stability that produce results as certain as those of the testing of distinctness and uniformity. However, experience has demonstrated that, for many types of variety, when a variety has been shown to be uniform, it can also be considered to be stable.

4.3.2 Where appropriate, or in cases of doubt, stability may be further examined by testing a new seed or plant stock to ensure that it exhibits the same characteristics as those shown by the initial material supplied.

### 5. Grouping of Varieties and Organization of the Growing Trial

5.1 The selection of varieties of common knowledge to be grown in the trial with the candidate varieties and the way in which these varieties are divided into groups to facilitate the assessment of distinctness are aided by the use of grouping characteristics.

5.2 Grouping characteristics are those in which the documented states of expression, even where produced at different locations, can be used, either individually or in combination with other such characteristics: (a) to select varieties of common knowledge that can be excluded from the growing trial used for examination of distinctness; and (b) to organize the growing trial so that similar varieties are grouped together.

5.3 The following have been agreed as useful grouping characteristics:

- (a) Plant: habit (characteristic 1)
- (b) Inflorescence: type (characteristic 29)
- (c) Inflorescence: predominant color (characteristic 31)
- (d) Perianth: color (characteristic 46)

5.4 Guidance for the use of grouping characteristics, in the process of examining distinctness, is provided through the General Introduction and document TGP/9 "Examining Distinctness".

## 6. Introduction to the Table of Characteristics

### 6.1 *Categories of Characteristics*

#### 6.1.1 Standard Test Guidelines Characteristics

Standard Test Guidelines characteristics are those which are approved by UPOV for examination of DUS and from which members of the Union can select those suitable for their particular circumstances.

#### 6.1.2 Asterisked Characteristics

Asterisked characteristics (denoted by \*) are those included in the Test Guidelines which are important for the international harmonization of variety descriptions and should always be examined for DUS and included in the variety description by all members of the Union, except when the state of expression of a preceding characteristic or regional environmental conditions render this inappropriate.

### 6.2 *States of Expression and Corresponding Notes*

6.2.1 States of expression are given for each characteristic to define the characteristic and to harmonize descriptions. Each state of expression is allocated a corresponding numerical note for ease of recording of data and for the production and exchange of the description.

6.2.2 In the case of qualitative and pseudo-qualitative characteristics (see Chapter 6.3), all relevant states of expression are presented in the characteristic. However, in the case of quantitative characteristics with 5 or more states, an abbreviated scale may be used to minimize the size of the Table of Characteristics. For example, in the case of a quantitative characteristic with 9 states, the presentation of states of expression in the Test Guidelines may be abbreviated as follows:

| <i>State</i> | <i>Note</i> |
|--------------|-------------|
| small        | 3           |
| medium       | 5           |
| large        | 7           |

However, it should be noted that all of the following 9 states of expression exist to describe varieties and should be used as appropriate:

| <i>State</i>        | <i>Note</i> |
|---------------------|-------------|
| very small          | 1           |
| very small to small | 2           |
| small               | 3           |
| small to medium     | 4           |
| medium              | 5           |
| medium to large     | 6           |
| large               | 7           |
| large to very large | 8           |
| very large          | 9           |

6.2.3 Further explanation of the presentation of states of expression and notes is provided in document TGP/7 "Development of Test Guidelines".

### 6.3 *Types of Expression*

An explanation of the types of expression of characteristics (qualitative, quantitative and pseudo-qualitative) is provided in the General Introduction.

### 6.4 *Example Varieties*

Where appropriate, example varieties are provided to clarify the states of expression of each characteristic.

6.5 Legend

|   |   | English                            | français                     | deutsch                       | español                        | Example Varieties<br>Exemples<br>Beispielsorten<br>Variedades ejemplo | Note/<br>Nota |
|---|---|------------------------------------|------------------------------|-------------------------------|--------------------------------|---|---------------|
| 1 | 2 | 3                                  | 4                            | 5                             | 6                              | 7   |               |
|   |   | Name of characteristics in English | Nom du caractère en français | Name des Merkmals auf Deutsch | Nombre del carácter en español |   |               |
|   |   | states of expression               | types d'expression           | Ausprägungsstufen             | tipos de expresión             |   |               |

- 1 Characteristic number
- 2 (\*) Asterisked characteristic – see Chapter 6.1.2
- 3 Type of expression  
 QL Qualitative characteristic – see Chapter 6.3  
 QN Quantitative characteristic – see Chapter 6.3  
 PQ Pseudo-qualitative characteristic – see Chapter 6.3
- 4 Method of observation (and type of plot, if applicable)  
 MG, MS, VG, VS – see Chapter 4.1.5
- 5 (+) See Explanations on the Table of Characteristics in Chapter 8.2
- 6 (a)-(c) See Explanations on the Table of Characteristics in Chapter 8.1
- 7 Not applicable

7. Table of Characteristics/Tableau des caractères/Merkmalstabelle/Tabla de caracteres

|               | English                          |                                      | français                          |                                     | deutsch                        | español | Example Varieties<br>Exemples<br>Beispielssorten<br>Variedades ejemplo | Note/<br>Nota |
|---------------|----------------------------------|--------------------------------------|-----------------------------------|-------------------------------------|--------------------------------|---------|--|---------------|
| <b>1. (*)</b> | <b>PQ</b>                        | <b>VG</b>                            | <b>(+)</b>                        | <b>(a)</b>                          |                                |         |  |               |
|               | <b>Plant: habit</b>              | <b>Plante : port</b>                 | <b>Pflanze: Wuchsform</b>         | <b>Planta: hábito</b>               |                                |         |  |               |
|               | upright                          | dressée                              | aufrecht                          | erecto                              | Callum's Gold                  |         | 1  |               |
|               | semi upright                     | demi-dressée                         | halbaufrecht                      | semierecto                          | Honey Gem                      |         | 2  |               |
|               | spreading                        | étalée                               | breitwüchsig                      | extendido                           | Ninderry-Sunrise               |         | 3  |               |
|               | prostrate                        | rampante                             | liegend                           | postrado                            | Raptor                         |         | 4  |               |
| <b>2. (*)</b> | <b>QN</b>                        | <b>MG/VG</b>                         | <b>(a)</b>                        |                                     |                                |         |  |               |
|               | <b>Plant: height</b>             | <b>Plante : hauteur</b>              | <b>Pflanze: Höhe</b>              | <b>Planta: altura</b>               |                                |         |  |               |
|               | short                            | basse                                | niedrig                           | baja                                | Jelly Baby                     |         | 3  |               |
|               | medium                           | moyenne                              | mittel                            | media                               | LowstenoGL                     |         | 5  |               |
|               | tall                             | haute                                | hoch                              | alta                                | Cream Passion                  |         | 7  |               |
| <b>3.</b>     | <b>QN</b>                        | <b>VG</b>                            | <b>(a)</b>                        |                                     |                                |         |  |               |
|               | <b>Plant: density of foliage</b> | <b>Plante : densité du feuillage</b> | <b>Pflanze: Dichte des Laubes</b> | <b>Planta: densidad del follaje</b> |                                |         |  |               |
|               | sparse                           | faible                               | locker                            | escaso                              | Raptor                         |         | 1  |               |
|               | medium                           | moyenne                              | mittel                            | medio                               | Callum's Gold                  |         | 2  |               |
|               | dense                            | forte                                | dicht                             | denso                               | Billy Bonkers                  |         | 3  |               |
| <b>4.</b>     | <b>PQ</b>                        | <b>VG</b>                            | <b>(+)</b>                        |                                     |                                |         |  |               |
|               | <b>Young stem: color</b>         | <b>Jeune tige : couleur</b>          | <b>Jungtrieb: Farbe</b>           | <b>Tallo joven: color</b>           |                                |         |  |               |
|               | green                            | vert                                 | grün                              | verde                               | Coastal Prestige,<br>Fireworks |         | 1  |               |
|               | yellow green                     | vert jaune                           | gelbgrün                          | verde amarillento                   | Honey Gem                      |         | 2  |               |
|               | orange                           | orange                               | orange                            | naranja                             | Callum's Gold                  |         | 3  |               |
|               | purple                           | pourpre                              | purpurn                           | púrpura                             | Raptor                         |         | 4  |               |
|               | brown                            | brun                                 | braun                             | marrón                              | Autumn Waterfall               |         | 5  |               |
| <b>5. (*)</b> | <b>PQ</b>                        | <b>VG</b>                            | <b>(+)</b>                        | <b>(a)</b>                          |                                |         |  |               |
|               | <b>Stem: color</b>               | <b>Tige : couleur</b>                | <b>Trieb: Farbe</b>               | <b>Tallo: color</b>                 |                                |         |  |               |
|               | green                            | vert                                 | grün                              | verde                               | Burke 3                        |         | 1  |               |
|               | yellow green                     | vert jaune                           | gelbgrün                          | verde amarillento                   | New Blood                      |         | 2  |               |
|               | orange                           | orange                               | orange                            | naranja                             | Ninderry-Sunrise               |         | 3  |               |
|               | purple                           | pourpre                              | purpurn                           | púrpura                             | Callum's Gold                  |         | 4  |               |
|               | brown                            | brun                                 | braun                             | marrón                              | Honey Gem                      |         | 5  |               |



|        | English  |    | français  |     | deutsch  |  | español  |  | Example Varieties<br>Exemples<br>Beispielsorten<br>Variedades ejemplo | Note/<br>Nota |
|--------|--|----|---|-----|--|--|--|--|---|---------------|
| 6. (*) | QN   | VG | (a)   |     |  |  |  |  |   |               |
|        | <b>Leaf: attitude relative to stem</b>   |    | <b>Feuille : orientation par rapport à la tige</b>  |     | <b>Blatt: Haltung im Verhältnis zum Trieb</b>  |  | <b>Hoja: porte en relación con el tallo</b>  |  |   |               |
|        | erect  |    | dressée   |     | aufrecht   |  | erecta   |  | Raptor  | 1             |
|        | semi erect   |    | demi-dressée  |     | halbaufrecht   |  | semierecta   |  | Callum's Gold   | 2             |
|        | horizontal   |    | horizontale   |     | waagrecht  |  | horizontal   |  | Prostrate Yellow  | 3             |
| 7. (*) | QL   | VG | (+)   | (a) |  |  |  |  |   |               |
|        | <b>Leaf: type of division of blade</b>   |    | <b>Feuille : type de division du limbe</b>  |     | <b>Blatt: Art der Fiederung der Blattspreite</b>   |  | <b>Hoja: tipo de división del limbo</b>  |  |   |               |
|        | entire   |    | entière   |     | ganzrandig   |  | entero   |  | Raptor  | 1             |
|        | primary  |    | primaire  |     | primär   |  | primaria   |  | Autumn Waterfall  | 2             |
|        | secondary  |    | secondaire  |     | sekundär   |  | secundaria   |  | Callum's Gold   | 3             |
|        | tertiary   |    | tertiaire   |     | tertiär  |  | terciaria  |  | Fire Cracker  | 4             |
| 8. (*) | PQ   | VG | (+)   | (a) |  |  |  |  |   |               |
|        | <b><u>Only varieties with Leaf: type of division of blade:</u></b><br><b>entire: Leaf: blade shape</b>   |    | <b><u>Seulement les variétés avec Feuille : type de division du limbe :</u></b><br><b>entière : Feuille : forme du limbe</b>  |     | <b><u>Nur Sorten mit Blatt: Art der Fiederung der Blattspreite:</u></b><br><b>ganzrandig: Blatt: Form der Blattspreite</b> |  | <b><u>Únicamente en variedades con Hoja: tipo de división del limbo: entero: Hoja: forma del limbo</u></b> |  |   |               |
|        | ovate  |    | ovale   |     | eiförmig   |  | oval   |  | Burke 3   | 1             |
|        | lanceolate   |    | lancéolé  |     | lanzettlich  |  | lanceolado   |  | H22   | 2             |
|        | circular   |    | circulaire  |     | rund   |  | circular   |  |   | 3             |
|        | rhombic  |    | losangique  |     | rhombisch  |  | rómico   |  | Molly   | 4             |
|        | elliptic   |    | elliptique  |     | elliptisch   |  | elíptico   |  | TWD01   | 5             |
|        | oblong   |    | oblong  |     | breitrund  |  | oblongo  |  |   | 6             |
|        | linear   |    | linéaire  |     | linear   |  | lineal   |  | Fire Cracker  | 7             |
|        | obovate  |    | obovale   |     | verkehrt eiförmig  |  | oboval   |  |   | 8             |
| 9.     | PQ   | VG | (+)   | (a) |  |  |  |  |   |               |
|        | <b><u>Only varieties with Leaf: type of division of blade:</u></b><br><b>entire: Leaf: shape of apex</b> |    | <b><u>Seulement les variétés avec Feuille : type de division du limbe :</u></b><br><b>entière : Feuille : forme de l'apex</b> |     | <b><u>Nur Sorten mit Blatt: Art der Fiederung der Blattspreite:</u></b><br><b>ganzrandig: Blatt: Form der Spitze</b>       |  | <b><u>Únicamente en variedades con Hoja: tipo de división del limbo: entero: Hoja: forma del ápice</u></b> |  |   |               |
|        | apiculate  |    | apiculé   |     | fein zugespitzt  |  | apiculado  |  | New Blood   | 1             |
|        | mucronate  |    | mucroné   |     | mit kurzer aufgesetzter Spitze   |  | mucronado  |  | H22   | 2             |
|        | acute  |    | aigu  |     | spitz  |  | agudo  |  | Little Honey  | 3             |
|        | obtuse   |    | obtus   |     | stumpf   |  | obtuso   |  |   | 4             |
|        | truncate   |    | tronqué   |     | gerade   |  | truncado   |  |   | 5             |

|            | English  |              | français   |            | deutsch   |  | español   |  | Example Varieties<br>Exemples<br>Beispielssorten<br>Variedades ejemplo | Note/<br>Nota |
|------------|--|--------------|--|------------|---|--|---|--|--|---------------|
| <b>10.</b> | <b>QN</b>  | <b>VG</b>    | <b>(a)</b>   |            |   |  |   |  |  |               |
|            | <b>Leaf: undulation of margin</b>                            |              | <b>Feuille : ondulation du bord</b>  |            | <b>Blatt: Wellung des Randes</b>  |  | <b>Hoja: ondulación del borde</b>   |  |  |               |
|            | weak   |              | faible   |            | schwach   |  | débil   |  | Callum's Gold  | 3             |
|            | medium   |              | moyenne  |            | mittel  |  | media   |  | Raptor   | 5             |
|            | strong   |              | forte  |            | stark   |  | fuerte  |  | Entrée   | 7             |
| <b>11.</b> | <b>QN</b>  | <b>VG</b>    | <b>(+)</b>   | <b>(a)</b> |   |  |   |  |  |               |
|            | <b>Leaf: depth of sinus of primary division</b>              |              | <b>Feuille : profondeur du sinus de la division primaire</b>               |            | <b>Blatt: Tiefe der Buchten der primären Fiederung</b>                        |  | <b>Hoja: profundidad de los senos de la división primaria</b>                 |  |  |               |
|            | shallow  |              | peu profond  |            | flach   |  | poco profundos  |  | Bedspread  | 1             |
|            | medium   |              | moyen  |            | mittel  |  | medios  |  | Callum's Gold  | 2             |
|            | deep   |              | profond  |            | tief  |  | profundos   |  |  | 3             |
| <b>12.</b> | <b>QN</b>  | <b>MS/VG</b> | <b>(+)</b>   | <b>(a)</b> |   |  |   |  |  |               |
|            | <b>Leaf: width of sinus of primary division</b>              |              | <b>Feuille : largeur du sinus de la division primaire</b>                  |            | <b>Blatt: Breite der Buchten der primären Fiederung</b>                       |  | <b>Hoja: anchura de los senos de la división primaria</b>                     |  |  |               |
|            | narrow   |              | étroit   |            | schmal  |  | estrechos   |  |  | 3             |
|            | medium   |              | moyen  |            | mittel  |  | medios  |  | Billy Bonkers  | 5             |
|            | broad  |              | large  |            | breit   |  | anchos  |  | Callum's Gold  | 7             |
| <b>13.</b> | <b>QN</b>  | <b>VG</b>    | <b>(+)</b>   | <b>(a)</b> |   |  |   |  |  |               |
|            | <b>Leaf: attitude of primary lobes in relation to midrib</b> |              | <b>Feuille : port des lobes primaires par rapport à la nervure médiane</b> |            | <b>Blatt: Haltung der Lappen erster Ordnung im Verhältnis zur Mittelrippe</b> |  | <b>Hoja: porte de los lóbulos primarios en relación con el nervio central</b> |  |  |               |
|            | erect  |              | dressés  |            | aufrecht  |  | erectos   |  |  | 1             |
|            | semi-erect   |              | demi-dressés   |            | halbaufrecht  |  | semierectos   |  | Callum's Gold  | 2             |
|            | horizontal   |              | horizontaux  |            | waagrecht   |  | horizontales  |  |  | 3             |
| <b>14.</b> | <b>PQ</b>  | <b>VG</b>    | <b>(+)</b>   | <b>(a)</b> |   |  |   |  |  |               |
|            | <b>Leaf: shape of apex of sinus of primary division</b>      |              | <b>Feuille : forme de l'apex du sinus de la division primaire</b>          |            | <b>Blatt: Form der Spitze der Buchten der primären Fiederung</b>              |  | <b>Hoja: forma del ápice de los senos de la división primaria</b>             |  |  |               |
|            | pointed  |              | pointu   |            | zugespitzt  |  | puntiagudo  |  | Ninderry-Sunrise   | 1             |
|            | rounded  |              | arrondi  |            | abgerundet  |  | redondeado  |  |  | 2             |
|            | truncated  |              | tronqué  |            | gerade  |  | truncado  |  |  | 3             |

|                | English   | français   | deutsch   | español  | Example Varieties<br>Exemples<br>Beispielsorten<br>Variedades ejemplo | Note/<br>Nota |
|----------------|---|--|---|--|---|---------------|
| <b>15. (*)</b> | <b>QN</b>   | <b>MS/VG</b>   | <b>(+)</b>  | <b>(a)</b>   |   |               |
|                | <b>Leaf: length of lobe of primary division</b>     | <b>Feuille : longueur du lobe de la division primaire</b>            | <b>Blatt: Länge des Lappens der primären Fiederung</b>  | <b>Hoja: longitud de los lóbulos de la división primaria</b> |   |               |
|                | short   | court  | kurz  | cortos   | Autumn Waterfall  | 3             |
|                | medium  | moyen  | mittel  | medianos   | Billy Bonkers   | 5             |
|                | long  | long   | lang  | largos   | Callum's Gold   | 7             |
| <b>16. (*)</b> | <b>QN</b>   | <b>MS/VG</b>   | <b>(+)</b>  | <b>(a)</b>   |   |               |
|                | <b>Leaf: width of lobe of primary division</b>      | <b>Feuille : largeur du lobe de la division primaire</b>             | <b>Blatt: Breite des Lappens der primären Fiederung</b> | <b>Hoja: anchura de los lóbulos de la división primaria</b>  |   |               |
|                | narrow  | étroit   | schmal  | estrechos  | Callum's Gold   | 3             |
|                | medium  | moyen  | mittel  | medios   | Ivory Whip  | 5             |
|                | broad   | large  | breit   | anchos   | Bedsread  | 7             |
| <b>17.</b>     | <b>PQ</b>   | <b>VG</b>  | <b>(+)</b>  | <b>(a)</b>   |   |               |
|                | <b>Leaf: profile in cross section</b>               | <b>Feuille : profil en section transversale</b>                      | <b>Blatt: Profil im Querschnitt</b>                     | <b>Hoja: perfil en sección transversal</b>                   |   |               |
|                | flat or slightly recurved                           | plat ou légèrement recourbé  | flach oder leicht gebogen                               | plana o ligeramente recurvada                                | Raptor  | 1             |
|                | strongly recurved                                   | fortement recourbé   | stark gebogen   | muy recurvada  | Callum's Gold   | 2             |
|                | angularly revolute to the mid vein                  | révoluté de façon angulaire jusqu'à la nervure principale            | kantig abwärts zur Hauptader gerollt                    | revoluta angulada hasta el nervio central                    |   | 3             |
|                | smoothly revolute to the mid vein                   | révoluté de façon lisse jusqu'à la nervure principale                | glatt abwärts zur Hauptader gerollt                     | revoluta lisa hasta el nervio central                        | Little Honey  | 4             |
| <b>18.</b>     | <b>QN</b>   | <b>VG</b>  |   | <b>(a)</b>   |   |               |
|                | <b>Leaf: intensity of green color of upper side</b> | <b>Feuille : intensité de la couleur verte de la face supérieure</b> | <b>Blatt: Intensität der Grünfärbung der Oberseite</b>  | <b>Hoja: intensidad del color verde del haz</b>              |   |               |
|                | light   | claire   | hell  | claro  | Autumn Waterfall  | 1             |
|                | medium  | moyenne  | mittel  | medio  | Raptor  | 2             |
|                | dark  | foncée   | dunkel  | oscuro   | Callum's Gold   | 3             |
| <b>19.</b>     | <b>PQ</b>   | <b>VG</b>  | <b>(+)</b>  | <b>(a)</b>   |   |               |
|                | <b>Leaf: color of lower side</b>                    | <b>Feuille : couleur de la face inférieure</b>                       | <b>Blatt: Farbe der Unterseite</b>                      | <b>Hoja: color del envés</b>                                 |   |               |
|                | white   | blanc  | weiß  | blanco   | Callum's Gold   | 1             |
|                | light green   | vert clair   | hellgrün  | verde claro  | Raptor  | 2             |
|                | medium green  | vert moyen   | mittelgrün  | verde medio  | Ninderry-Sunrise  | 3             |
|                | dark green  | vert foncé   | dunkelgrün  | verde oscuro   | Entrée  | 4             |

|                | English  |   | français   | deutsch   | español                         | Example Varieties<br>Exemples<br>Beispielsorten<br>Variedades ejemplo | Note/<br>Nota |
|----------------|--|---|--|---|---------------------------------|---|---------------|
| <b>20.</b>     | <b>QN</b>  | <b>VG</b>   | <b>(a)</b>   |   |                                 |   |               |
|                | <b>Leaf: hairiness of upper side</b>               | <b>Feuille : pilosité de la face supérieure</b>               | <b>Blatt: Behaarung der Oberseite</b>              | <b>Hoja: vellosidad del haz</b>                         |                                 |   |               |
|                | weak   | faible  | gering   | escasa  | Ninderry-Sunrise                | 1   |               |
|                | medium   | moyenne   | mittel   | media   | Callum's Gold                   | 2   |               |
|                | strong   | forte   | stark  | abundante   |                                 | 3   |               |
| <b>21.</b>     | <b>QN</b>  | <b>VG</b>   | <b>(a)</b>   |   |                                 |   |               |
|                | <b>Leaf: hairiness of lower side</b>               | <b>Feuille : pilosité de la face inférieure</b>               | <b>Blatt: Behaarung der Unterseite</b>             | <b>Hoja: vellosidad del envés</b>                       |                                 |   |               |
|                | weak   | faible  | gering   | escasa  | Little Honey                    | 1   |               |
|                | medium   | moyenne   | mittel   | media   | Blood Orange                    | 2   |               |
|                | strong   | forte   | stark  | abundante   | Ninderry-Sunrise                | 3   |               |
| <b>22.</b>     | <b>QL</b>  | <b>VG</b>   | <b>(a)</b>   |   |                                 |   |               |
|                | <b>Leaf: color of hairs on lower side</b>          | <b>Feuille : couleur de la pilosité de la face inférieure</b> | <b>Blatt: Farbe der Behaarung der Unterseite</b>   | <b>Hoja: color de la vellosidad del envés</b>           |                                 |   |               |
|                | white  | blanc   | weiß   | blanca  | Callum's Gold                   | 1   |               |
|                | red brown  | brun rouge  | rotbraun   | marrón rojiza   | Honey Gem                       | 2   |               |
| <b>23.</b>     | <b>QN</b>  | <b>MS/VG</b>  | <b>(+)</b>   | <b>(a)</b>  |                                 |   |               |
|                | <b>Leaf: length of petiole</b>                     | <b>Feuille : longueur du pétiole</b>                          | <b>Blatt: Länge des Stiels</b>                     | <b>Hoja: longitud del pecíolo</b>                       |                                 |   |               |
|                | short  | court   | kurz   | corto   | Raptor                          | 3   |               |
|                | medium   | moyen   | mittel   | medio   | Callum's Gold                   | 5   |               |
|                | long   | long  | lang   | largo   | Red Rover                       | 7   |               |
| <b>24.</b>     | <b>QL</b>  | <b>VG</b>   | <b>(b)</b>   |   |                                 |   |               |
|                | <b>Flowering branch: position of inflorescence</b> | <b>Rameau florifère : position de l'inflorescence</b>         | <b>Blühender Trieb: Position des Blütenstandes</b> | <b>Rama en floración: posición de la inflorescencia</b> |                                 |   |               |
|                | terminal only                                      | seulement terminale   | nur terminal                                       | solamente terminal                                      | Ninderry-Sunrise                | 1   |               |
|                | both terminal and axillary                         | terminale et axillaire  | sowohl terminal als auch axilar                    | terminal y axilar                                       | Callum's Gold                   | 2   |               |
|                | axillary only                                      | seulement axillaire   | nur axilar   | solamente axilar  |                                 | 3   |               |
| <b>25. (*)</b> | <b>QN</b>  | <b>VG</b>   | <b>(+)</b>   | <b>(b)</b>  |                                 |   |               |
|                | <b>Inflorescence: attitude</b>                     | <b>Inflorescence : port</b>                                   | <b>Blütenstand: Haltung</b>                        | <b>Inflorescencia: porte</b>                            |                                 |   |               |
|                | erect  | dressée   | aufrecht   | erecta  | Little Honey, Red Rover         | 1   |               |
|                | semi-erect   | demi-dressée  | halbaufrecht                                       | semierecta  | Blood Orange, Honey Gem         | 2   |               |
|                | horizontal   | horizontale   | waagrecht  | horizontal  | Callum's Gold, Ninderry-Sunrise | 3   |               |
|                | drooping   | retombante  | hängend  | colgante  | Entrée                          | 4   |               |

|                | English  |  | français   | deutsch  | español          | Example Varieties<br>Exemples<br>Beispielsorten<br>Variedades ejemplo | Note/<br>Nota |
|----------------|--|--|--|--|------------------|---|---------------|
| <b>26.</b>     | <b>QN</b>  | <b>VG</b>  | <b>(a), (b)</b>                                    |  |                  |   |               |
|                | <b>Inflorescence: branching</b>                  | <b>Inflorescence : ramification</b>                        | <b>Blütenstand: Verzweigung</b>                    | <b>Inflorescencia: ramificación</b>                    |                  |   |               |
|                | absent or very weak                              | absente ou très faible                                     | fehlend oder sehr gering                           | ausente o muy escasa                                   | Ninderry-Sunrise |   | 1             |
|                | weak   | faible   | gering   | escasa   | Red Rover        |   | 2             |
|                | medium   | moyenne  | mittel   | media  | Autumn Waterfall |   | 3             |
|                | strong   | forte  | stark  | abundante  |                  |   | 4             |
|                | very strong                                      | très forte   | sehr stark   | muy abundante  |                  |   | 5             |
| <b>27. (*)</b> | <b>QN</b>  | <b>MS/VG</b>   | <b>(+) (b)</b>                                     |  |                  |   |               |
|                | <b>Inflorescence: length</b>                     | <b>Inflorescence : longueur</b>                            | <b>Blütenstand: Länge</b>                          | <b>Inflorescencia: longitud</b>                        |                  |   |               |
|                | short  | courte   | kurz   | corta  | Raptor           |   | 1             |
|                | medium   | moyenne  | mittel   | media  | Callum's Gold    |   | 2             |
|                | long   | longue   | lang   | larga  | Autumn Waterfall |   | 3             |
| <b>28. (*)</b> | <b>QN</b>  | <b>MS/VG</b>   | <b>(b)</b>   |  |                  |   |               |
|                | <b>Inflorescence: width</b>                      | <b>Inflorescence : largeur</b>                             | <b>Blütenstand: Breite</b>                         | <b>Inflorescencia: anchura</b>                         |                  |   |               |
|                | narrow   | étroite  | schmal   | estrecha   | Raptor           |   | 1             |
|                | medium   | moyenne  | mittel   | media  | Callum's Gold    |   | 2             |
|                | broad  | large  | breit  | ancha  | Red Rover        |   | 3             |
| <b>29. (*)</b> | <b>PQ</b>  | <b>VG</b>  | <b>(+) (b)</b>                                     |  |                  |   |               |
|                | <b>Inflorescence: type</b>                       | <b>Inflorescence : type</b>                                | <b>Blütenstand: Typ</b>                            | <b>Inflorescencia: tipo</b>                            |                  |   |               |
|                | secund   | unilatérale  | einseitswendig                                     | unilateral   | Ninderry-Sunrise |   | 1             |
|                | irregular  | irrégulière  | unregelmäßig                                       | irregular  | LadyO            |   | 2             |
|                | cylindrical                                      | cylindrique  | zylindrisch  | cilíndrica   | Callum's Gold    |   | 3             |
|                | triangular                                       | triangulaire   | dreieckig  | triangular   | Fireworks        |   | 4             |
|                | umbellate  | en ombelle   | doldenförmig                                       | umbelada   |                  |   | 5             |
|                | ovoid  | ovoïde   | eiartig  | ovoide   |                  |   | 6             |
|                | domed  | en dôme  | gewölbt  | abovedada  | H22              |   | 7             |
| <b>30. (*)</b> | <b>QL</b>  | <b>VG</b>  | <b>(+) (b)</b>                                     |  |                  |   |               |
|                | <b>Inflorescence: sequence of flower opening</b> | <b>Inflorescence : séquence de l'ouverture de la fleur</b> | <b>Blütenstand: Abfolge des Öffnens der Blüten</b> | <b>Inflorescencia: orden de apertura de las flores</b> |                  |   |               |
|                | acropetal  | acropète   | akropetal  | acrópeta   | Callum's Gold    |   | 1             |
|                | synchronous                                      | synchrone  | synchron   | sincrónica   | Coastal Prestige |   | 2             |
|                | basipetal  | basipète   | basipetal  | basípeta   | Knockout         |   | 3             |

|            | English    |   | français  | deutsch   | español  | Example Varieties<br>Exemples<br>Beispielssorten<br>Variedades ejemplo | Note/<br>Nota |
|------------|------------|---|---|---|--|--|---------------|
| <b>31.</b> | <b>(*)</b> | <b>PQ</b>   | <b>VG</b>   | <b>(b)</b>  |  |  |               |
|            |            | <b>Inflorescence:<br/>predominant color</b>       | <b>Inflorescence :<br/>couleur prédominante</b>   | <b>Blütenstand:<br/>vorwiegende Farbe</b>                 | <b>Inflorescencia: color<br/>predominante</b>      |  |               |
|            |            | white   | blanc   | weiß  | blanco   | Ivory Whip   | 1             |
|            |            | green   | vert  | grün  | verde  |  | 2             |
|            |            | yellow  | jaune   | gelb  | amarillo   | Callum's Gold  | 3             |
|            |            | orange  | orange  | orange  | naranja  | Ninderry-Sunrise   | 4             |
|            |            | pink  | rose  | rosa  | rosa   | Blood Orange   | 5             |
|            |            | red   | rouge   | rot   | rojo   | Raptor   | 6             |
| <b>32.</b> |            | <b>QN</b>   | <b>VG</b>   | <b>(b)</b>  |  |  |               |
|            |            | <b>Inflorescence: density<br/>of flowers</b>      | <b>Inflorescence : densité<br/>des fleurs</b>     | <b>Blütenstand: Dichte<br/>der Blüten</b>                 | <b>Inflorescencia:<br/>densidad de las flores</b>  |  |               |
|            |            | sparse  | faible  | locker  | baja   | Coastal Dawn   | 3             |
|            |            | medium  | moyenne   | mittel  | media  | Honey Gem  | 5             |
|            |            | dense   | forte   | dicht   | alta   | Callum's Gold  | 7             |
| <b>33.</b> |            | <b>QN</b>   | <b>MS/VG</b>                                      | <b>(b)</b>  |  |  |               |
|            |            | <b>Inflorescence: number<br/>of flowers</b>       | <b>Inflorescence :<br/>nombre de fleurs</b>       | <b>Blütenstand: Anzahl<br/>der Blüten</b>                 | <b>Inflorescencia:<br/>número de flores</b>        |  |               |
|            |            | few   | petit   | wenige  | bajo   | Fire Cracker   | 3             |
|            |            | medium  | moyen   | mittel  | medio  | Raptor   | 5             |
|            |            | many  | grand   | viele   | alto   | Red Rover  | 7             |
| <b>34.</b> |            | <b>QN</b>   | <b>MS/VG</b>                                      | <b>(b)</b>  |  |  |               |
|            |            | <b>Inflorescence: length<br/>of rachis</b>        | <b>Inflorescence :<br/>longueur du rachis</b>     | <b>Blütenstand: Länge<br/>der Spindel</b>                 | <b>Inflorescencia:<br/>longitud del raquis</b>     |  |               |
|            |            | short   | court   | kurz  | corto  | Raptor   | 3             |
|            |            | medium  | moyen   | mittel  | medio  | Callum's Gold  | 5             |
|            |            | long  | long  | lang  | largo  | Honey Gem  | 7             |
| <b>35.</b> |            | <b>QN</b>   | <b>VG</b>   | <b>(+)</b>  | <b>(b), (c)</b>                                    |  |               |
|            |            | <b>Pedice: attitude in<br/>relation to rachis</b> | <b>Pédicelle : port par<br/>rapport au rachis</b> | <b>Blütenstiel: Haltung im<br/>Verhältnis zur Spindel</b> | <b>Pedice: porte en<br/>relación con el raquis</b> |  |               |
|            |            | leaning towards the<br>apex                       | penché vers l'apex                                | zur Spitze geneigt  | inclinado hacia el ápice                           | Callum's Gold  | 1             |
|            |            | perpendicular                                     | perpendiculaire                                   | rechtwinklig  | perpendicular                                      | Ninderry-Sunrise   | 2             |
|            |            | leaning towards the<br>base                       | penché vers la base                               | zur Basis geneigt   | inclinado hacia la base                            | Autumn Waterfall   | 3             |

|                | English   | français  | deutsch  | español   | Example Varieties<br>Exemples<br>Beispielssorten<br>Variedades ejemplo | Note/<br>Nota |
|----------------|---|---|--|---|--|---------------|
| <b>36.</b>     | <b>QN MS/VG</b>   | <b>(b), (c)</b>   |  |   |  |               |
|                | <b>Pediceal: length</b>   | <b>Pédicelle : longueur</b>   | <b>Blütenstiel: Länge</b>  | <b>Pedicele: longitud</b>   |  |               |
|                | very short  | très court  | sehr kurz  | muy corto   |  | 1             |
|                | short   | court   | kurz   | corto   | Callum's Gold  | 2             |
|                | medium  | moyen   | mittel   | medio   | Billy Bonkers  | 3             |
|                | long  | long  | lang   | largo   | Autumn Waterfall   | 4             |
|                | very long   | très long   | sehr lang  | muy largo   |  | 5             |
| <b>37.</b>     | <b>QN VG</b>  | <b>(+), (b), (c)</b>  |  |   |  |               |
|                | <b>Flower bud: attitude of limb in relation to longitudinal axis of bud</b> | <b>Bouton floral : port du limbe par rapport à l'axe longitudinal du bouton</b> | <b>Blütenknospe: Haltung des Kelchsaumes im Verhältnis zur Längsachse der Knospe</b> | <b>Botón floral: porte del limbo en relación con el eje longitudinal del botón floral</b> |  |               |
|                | upright   | dressé  | aufrecht   | erecto  | Ninderry-Sunrise   | 1             |
|                | horizontal  | horizontal  | waagrecht  | horizontal  | New Blood  | 2             |
|                | drooping  | retombant   | hängend  | colgante  | Callum's Gold  | 3             |
| <b>38. (*)</b> | <b>PQ VG</b>  | <b>(b), (c)</b>   |  |   |  |               |
|                | <b>Flower bud: color of limb</b>  | <b>Bouton floral : couleur du limbe</b>   | <b>Blütenknospe: Farbe des Kelchsaumes</b>   | <b>Botón floral: color del limbo</b>  |  |               |
|                | green   | vert  | grün   | verde   | Callum's Gold  | 1             |
|                | yellow  | jaune   | gelb   | amarillo  | Honey Gem  | 2             |
|                | orange  | orange  | orange   | naranja   | Sylvia   | 3             |
|                | pink  | rose  | rosa   | rosa  | Winter Delight   | 4             |
|                | red   | rouge   | rot  | rojo  | Raptor   | 5             |
|                | brown   | marron  | braun  | marrón  | New Blood  | 7             |
| <b>39. (*)</b> | <b>PQ VG</b>  | <b>(b), (c)</b>   |  |   |  |               |
|                | <b>Flower bud: perianth color</b>   | <b>Bouton floral : couleur du périanthe</b>                                     | <b>Blütenknospe: Farbe der Blütenhülle</b>   | <b>Botón floral: color del perianto</b>   |  |               |
|                | white   | blanc   | weiß   | blanco  | Ivory Whip   | 1             |
|                | green   | vert  | grün   | verde   | Ninderry-Sunrise   | 2             |
|                | yellow  | jaune   | gelb   | amarillo  | Callum's Gold  | 3             |
|                | orange  | orange  | orange   | naranja   | Entrée   | 4             |
|                | pink  | rose  | rosa   | rosa  | Molly  | 5             |
|                | red   | rouge   | rot  | rojo  | Raptor   | 6             |
| <b>40. (*)</b> | <b>QN MS/VG</b>   | <b>(b), (c)</b>   |  |   |  |               |
|                | <b>Perianth: length</b>   | <b>Périanthe : longueur</b>   | <b>Blütenhülle: Länge</b>  | <b>Perianto: longitud</b>   |  |               |
|                | short   | court   | kurz   | corto   | Raptor   | 3             |
|                | medium  | moyen   | mittel   | medio   | Callum's Gold  | 5             |
|                | long  | long  | lang   | largo   | Red Rover  | 7             |

|                | English  |   | français   | deutsch   | español          | Example Varieties<br>Exemples<br>Beispielssorten<br>Variedades ejemplo | Note/<br>Nota |
|----------------|--|---|--|---|------------------|--|---------------|
| <b>41. (*)</b> | <b>QN</b>  | <b>MS/VG</b>                                      | <b>(b), (c)</b>  |   |                  |  |               |
|                | <b>Perianth: width</b>                               | <b>Périanthe : largeur</b>                        | <b>Blütenhülle: Breite</b>   | <b>Perianto: anchura</b>                                    |                  |  |               |
|                | narrow   | étroit  | schmal   | estrecho  | Callum's Gold    |  | 3             |
|                | medium   | moyen   | mittel   | medio   | Ninderry-Sunrise |  | 5             |
|                | broad  | large   | breit  | ancho   | Entrée           |  | 7             |
| <b>42. (*)</b> | <b>QN</b>  | <b>VG</b>   | <b>(+)</b> <b>(b), (c)</b>   |   |                  |  |               |
|                | <b>Perianth: hairiness</b>                           | <b>Périanthe : pilosité</b>                       | <b>Blütenhülle: Behaarung</b>  | <b>Perianto: vellosidad</b>                                 |                  |  |               |
|                | absent or very weak                                  | nulle ou très faible                              | fehlend oder sehr gering   | ausente o muy escasa  | Ninderry-Sunrise |  | 1             |
|                | weak   | faible  | gering   | escasa  | Honey Gem        |  | 2             |
|                | medium   | moyenne   | mittel   | media   | Raptor           |  | 3             |
|                | strong   | forte   | stark  | abundante   | Callum's Gold    |  | 4             |
|                | very strong  | très forte  | sehr stark   | muy abundante   |                  |  | 5             |
| <b>43.</b>     | <b>QL</b>  | <b>VG</b>   | <b>(b), (c)</b>  |   |                  |  |               |
|                | <b>Perianth: hair color</b>                          | <b>Périanthe : couleur de la pilosité</b>         | <b>Blütenhülle: Farbe der Behaarung</b>                              | <b>Perianto: color de la vellosidad</b>                     |                  |  |               |
|                | white  | blanc   | weiß   | blanca  | Raptor           |  | 1             |
|                | red brown  | brun rouge  | rotbraun   | marrón rojiza   | Callum's Gold    |  | 2             |
| <b>44.</b>     | <b>QN</b>  | <b>VG</b>   | <b>(+)</b> <b>(b), (c)</b>   |   |                  |  |               |
|                | <b>Perianth: coherence of tepals on dorsal side</b>  | <b>Périanthe : cohérence des tépales dorsaux</b>  | <b>Blütenhülle: Anhaftung der Perigonblätter auf der Rückenseite</b> | <b>Perianto: cohesión de los tépalos de la cara dorsal</b>  |                  |  |               |
|                | less than one third                                  | moins d'un tiers                                  | weniger als ein Drittel  | menos de un tercio  | Ninderry-Sunrise |  | 1             |
|                | one third to two thirds                              | un tiers à deux tiers                             | ein Drittel bis zwei Drittel   | de un tercio a dos tercios                                  | Molly            |  | 2             |
|                | greater than two thirds                              | plus des deux tiers                               | mehr als zwei Drittel  | más de dos tercios  | Callum's Gold    |  | 3             |
| <b>45.</b>     | <b>QN</b>  | <b>VG</b>   | <b>(+)</b> <b>(b), (c)</b>   |   |                  |  |               |
|                | <b>Perianth: coherence of tepals on ventral side</b> | <b>Périanthe : cohérence des tépales ventraux</b> | <b>Blütenhülle: Anhaftung der Perigonblätter auf der Bauchseite</b>  | <b>Perianto: cohesión de los tépalos de la cara ventral</b> |                  |  |               |
|                | less than one third                                  | moins d'un tiers                                  | weniger als ein Drittel  | menos de un tercio  | Ninderry-Sunrise |  | 1             |
|                | one third to two thirds                              | un tiers à deux tiers                             | ein Drittel bis zwei Drittel   | de un tercio a dos tercios                                  | Molly            |  | 2             |
|                | greater than two thirds                              | plus des deux tiers                               | mehr als zwei Drittel  | más de dos tercios  | Callum's Gold    |  | 3             |



|                | English   |   | français  |  | deutsch          | español | Example Varieties<br>Exemples<br>Beispielsorten<br>Variedades ejemplo | Note/<br>Nota |
|----------------|---|---|---|--|------------------|---------|---|---------------|
| <b>46. (*)</b> | <b>PQ</b>   | <b>VG</b>   | <b>(+)</b>  | <b>(b), (c)</b>                                      |                  |         |   |               |
|                | <b>Perianth: color</b>                                  | <b>Périanthe : couleur</b>                        | <b>Blütenhülle: Farbe</b>                           | <b>Perianto: color</b>                               |                  |         |   |               |
|                | white   | blanc   | weiß  | blanco   | Ivory Whip       |         | 1   |               |
|                | green   | vert  | grün  | verde  | Sandra Gordon    |         | 2   |               |
|                | yellow  | jaune   | gelb  | amarillo   | Callum's Gold    |         | 3   |               |
|                | orange  | orange  | orange  | naranja  | Ninderry-Sunrise |         | 4   |               |
|                | pink  | rose  | rosa  | rosa   | Blood Orange     |         | 5   |               |
|                | red   | rouge   | rot   | rojo   | Raptor           |         | 6   |               |
| <b>47.</b>     | <b>QN</b>   | <b>VG</b>   |   | <b>(b), (c)</b>                                      |                  |         |   |               |
|                | <b>Pistil: length</b>                                   | <b>Pistil : longueur</b>                          | <b>Stempel: Länge</b>                               | <b>Pistilo: longitud</b>                             |                  |         |   |               |
|                | short   | court   | kurz  | corto  | Knockout         |         | 3   |               |
|                | medium  | moyen   | mittel  | medio  | Ninderry-Sunrise |         | 5   |               |
|                | long  | long  | lang  | largo  | Callum's Gold    |         | 7   |               |
| <b>48.</b>     | <b>QN</b>   | <b>VG</b>   |   | <b>(b), (c)</b>                                      |                  |         |   |               |
|                | <b>Pistil: length in relation to length of perianth</b> | <b>Pistil : longueur par rapport au périanthe</b> | <b>Stempel: Länge im Verhältnis zur Blütenhülle</b> | <b>Pistilo: longitud en relación con el perianto</b> |                  |         |   |               |
|                | same length   | même longueur                                     | gleiche Länge                                       | igual de largo                                       |                  |         | 1   |               |
|                | moderately longer                                       | modérément plus long                              | mäßig länger  | moderadamente más largo                              | Ivory Whip       |         | 2   |               |
|                | much longer   | beaucoup plus long                                | viel länger   | mucho más largo                                      | Callum's Gold    |         | 3   |               |
| <b>49.</b>     | <b>QN</b>   | <b>VG</b>   |   | <b>(b), (c)</b>                                      |                  |         |   |               |
|                | <b>Ovary: hairiness</b>                                 | <b>Ovaire : pilosité</b>                          | <b>Fruchtknoten: Behaarung</b>                      | <b>Ovario: vellosidad</b>                            |                  |         |   |               |
|                | absent or very weak                                     | nulle ou très faible                              | fehlend oder sehr gering                            | ausente o muy escasa                                 | Knockout         |         | 1   |               |
|                | weak  | faible  | gering  | escasa   | Jubilee          |         | 2   |               |
|                | medium  | moyenne   | mittel  | media  | Raptor           |         | 3   |               |
|                | strong  | forte   | stark   | abundante  | Callum's Gold    |         | 4   |               |
|                | very strong   | très forte  | sehr stark  | muy abundante  |                  |         | 5   |               |
| <b>50.</b>     | <b>PQ</b>   | <b>VG</b>   |   | <b>(b), (c)</b>                                      |                  |         |   |               |
|                | <b>Ovary: color</b>                                     | <b>Ovaire : couleur</b>                           | <b>Fruchtknoten: Farbe</b>                          | <b>Ovario: color</b>                                 |                  |         |   |               |
|                | white   | blanc   | weiß  | blanco   | Raptor           |         | 1   |               |
|                | green   | vert  | grün  | verde  | Callum's Gold    |         | 2   |               |
|                | yellow  | jaune   | gelb  | Amarillo   | Honey Gem        |         | 3   |               |
|                | orange  | orange  | orange  | naranja  |                  |         | 4   |               |
|                | pink  | rose  | rosa  | rosa   | Goldfever        |         | 5   |               |
|                | red   | rouge   | rot   | rojo   |                  |         | 6   |               |

|                | English                            |   | français                                 |   | deutsch                   | español | Example Varieties<br>Exemples<br>Beispielsorten<br>Variedades ejemplo | Note/<br>Nota |
|----------------|------------------------------------|---|--|---|---------------------------|---------|---|---------------|
| <b>51.</b>     | <b>PQ</b>                          | <b>VG</b>                                 | <b>(+)</b>                               | <b>(b), (c)</b>                                 |                           |         |   |               |
|                | <b>Style: curvature</b>            | <b>Style : courbure</b>                   | <b>Griffel: Biegung</b>                  | <b>Estilo: curvatura</b>                        |                           |         |   |               |
|                | straight                           | droit                                     | gerade                                   | recto   | Callum's Gold             |         | 1   |               |
|                | curved                             | courbé                                    | gebogen                                  | curvado   | Ninderry-Sunrise          |         | 2   |               |
|                | reflexed                           | réfléchi                                  | abgeknickt                               | reflexo   | Pink Surprise             |         | 3   |               |
| <b>52.</b>     | <b>QN</b>                          | <b>VG</b>                                 |  | <b>(b), (c)</b>                                 |                           |         |   |               |
|                | <b>Style: hairiness</b>            | <b>Style : pilosité</b>                   | <b>Griffel: Behaarung</b>                | <b>Estilo: vellosidad</b>                       |                           |         |   |               |
|                | absent or weak                     | absente ou faible                         | fehlend oder gering                      | ausente o débil                                 | Callum's Gold, Ivory Whip |         | 1   |               |
|                | medium                             | moyenne                                   | mittel                                   | media   | Entrée                    |         | 2   |               |
|                | strong                             | forte                                     | stark                                    | abundante                                       |                           |         | 3   |               |
| <b>53.</b>     | <b>QN</b>                          | <b>VG</b>                                 |  | <b>(b), (c)</b>                                 |                           |         |   |               |
|                | <b>Style: distribution of hair</b> | <b>Style : répartition de la pilosité</b> | <b>Griffel: Verteilung der Behaarung</b> | <b>Estilo: distribución de la vellosidad</b>    |                           |         |   |               |
|                | concentrated towards style end     | concentrée vers l'extrémité du style      | konzentriert zum Griffelende hin         | concentrada hacia el extremo del estilo         |                           |         | 1   |               |
|                | evenly distributed along length    | répartie uniformément sur la longueur     | längs gleichmäßig verteilt               | distribuida uniformemente a lo largo del estilo | Entrée                    |         | 2   |               |
|                | concentrated towards ovary end     | concentrée vers l'extrémité de l'ovaire   | konzentriert zum Fruchtknotenende hin    | concentrada hacia el extremo del ovario         | Ninderry-Sunrise          |         | 3   |               |
| <b>54. (*)</b> | <b>PQ</b>                          | <b>VG</b>                                 |  | <b>(b), (c)</b>                                 |                           |         |   |               |
|                | <b>Style: color</b>                | <b>Style : couleur</b>                    | <b>Griffel: Farbe</b>                    | <b>Estilo: color</b>                            |                           |         |   |               |
|                | white                              | blanc                                     | weiß                                     | blanco  | Ivory Whip                |         | 1   |               |
|                | green                              | vert                                      | grün                                     | verde   | Misty Pink                |         | 2   |               |
|                | yellow                             | jaune                                     | gelb                                     | amarillo  | Golden Yul-lo             |         | 3   |               |
|                | orange                             | orange                                    | orange                                   | naranja   | Callum's Gold             |         | 4   |               |
|                | pink                               | rose                                      | rosa                                     | rosa  | Knockout                  |         | 5   |               |
|                | red                                | rouge                                     | rot                                      | rojo  | Raptor                    |         | 6   |               |
| <b>55.</b>     | <b>PQ</b>                          | <b>VG</b>                                 |  | <b>(b), (c)</b>                                 |                           |         |   |               |
|                | <b>Stigma: color</b>               | <b>Stigmates : couleur</b>                | <b>Narbe: Farbe</b>                      | <b>Estigma: color</b>                           |                           |         |   |               |
|                | white                              | blanc                                     | weiß                                     | blanco  | Knockout                  |         | 1   |               |
|                | green                              | vert                                      | grün                                     | verde   | Raptor                    |         | 2   |               |
|                | yellow                             | jaune                                     | gelb                                     | amarillo  | Callum's Gold             |         | 3   |               |
|                | orange                             | orange                                    | orange                                   | naranja   | Jubilee                   |         | 4   |               |
|                | pink                               | rose                                      | rosa                                     | rosa  | Billy Bonkers             |         | 5   |               |
|                | red                                | rouge                                     | rot                                      | rojo  | Red Rover                 |         | 6   |               |

|            | English    |  | français  |  | deutsch   | español          | Example Varieties<br>Exemples<br>Beispielsorten<br>Variedades ejemplo | Note/<br>Nota |
|------------|------------|--|---|--|---|------------------|---|---------------|
| <b>56.</b> | <b>(*)</b> | <b>PQ</b>                                      | <b>VG</b>   | <b>(+)</b>                                   | <b>(b), (c)</b>   |                  |   |               |
|            |            | <b>Pollen presenter:<br/>attitude to style</b> | <b>Présentateur de<br/>pollen : port par<br/>rapport au style</b> | <b>Pollenträger: Haltung<br/>zum Griffel</b> | <b>Presentador de polen:<br/>posición respecto del<br/>estilo</b> |                  |   |               |
|            |            | lateral  | latéral   | seitlich                                     | lateral   | Honey Gem        | 1   |               |
|            |            | oblique  | oblique   | schräg abstehend                             | oblicuo   | Callum's Gold    | 2   |               |
|            |            | transverse                                     | transversal   | quer   | transversal   |                  | 3   |               |
| <b>57.</b> | <b>(*)</b> | <b>PQ</b>                                      | <b>VG</b>   | <b>(+)</b>                                   | <b>(b), (c)</b>   |                  |   |               |
|            |            | <b>Pollen presenter:<br/>shape</b>             | <b>Présentateur de<br/>pollen : forme</b>                         | <b>Pollenträger: Form</b>                    | <b>Presentador de polen:<br/>forma</b>                            |                  |   |               |
|            |            | domed  | en dôme   | gewölbt                                      | abovedado   | Callum's Gold    | 1   |               |
|            |            | flat   | plan  | flach  | plano   | LadyO            | 2   |               |
|            |            | conic  | conique   | kegelförmig                                  | cónico  | Raptor           | 3   |               |
|            |            | cylindric                                      | cylindrique   | zylindrisch                                  | cilíndrico  | Honey Gem        | 4   |               |
| <b>58.</b> | <b>(*)</b> | <b>PQ</b>                                      | <b>VG</b>   |  | <b>(b), (c)</b>   |                  |   |               |
|            |            | <b>Pollen presenter: color</b>                 | <b>Présentateur de<br/>pollen : couleur</b>                       | <b>Pollenträger: Farbe</b>                   | <b>Presentador de polen:<br/>color</b>                            |                  |   |               |
|            |            | white  | blanc   | weiß   | blanco  | Billy Bonkers    | 1   |               |
|            |            | green  | vert  | grün   | verde   | Raptor           | 2   |               |
|            |            | yellow   | jaune   | gelb   | amarillo  | Callum's Gold    | 3   |               |
|            |            | orange   | orange  | orange                                       | naranja   | Autumn Waterfall | 4   |               |
|            |            | pink   | rose  | rosa   | rosa  | Fireworks        | 5   |               |
|            |            | red  | rouge   | rot  | rojo  | LadyO            | 6   |               |
| <b>59.</b> |            | <b>PQ</b>                                      | <b>VG</b>   |  | <b>(b)</b>  |                  |   |               |
|            |            | <b>Pollen: color</b>                           | <b>Pollen : couleur</b>   | <b>Pollen: Farbe</b>                         | <b>Polen: color</b>   |                  |   |               |
|            |            | white  | blanc   | weiß   | blanco  | Little Honey     | 1   |               |
|            |            | yellow   | jaune   | gelb   | amarillo  | Callum's Gold    | 2   |               |
|            |            | purple   | violet  | purpurn                                      | púrpura   | Raptor           | 3   |               |

8. Explanations on the Table of Characteristics

8.1 *Explanations covering several characteristics*

Characteristics containing the following key in the Table of Characteristics should be examined as indicated below:

- (a) Observations should be made towards the end of active vegetative growth.
- (b) Observations should be made at the broadest part of a main flowering branch.
- (c)

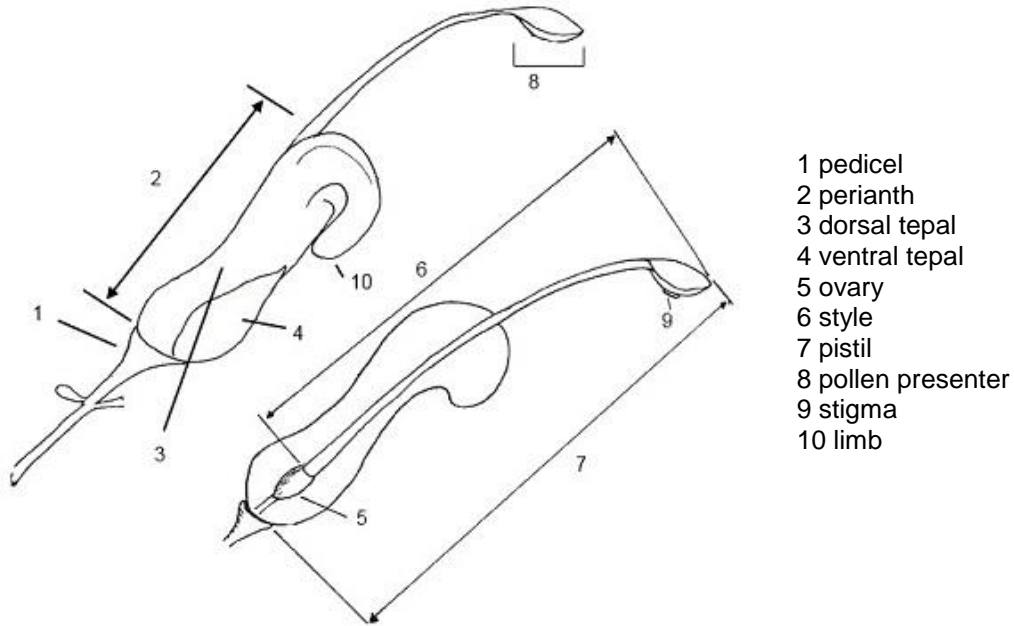

8.2 *Explanations for individual characteristics*

Ad. 1: Plant: habit

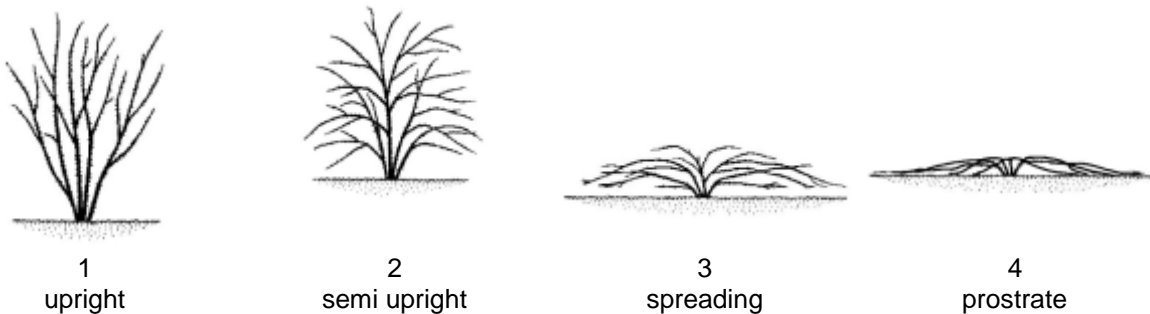

Ad. 4: Young stem: color

Observations on the young stem below the shoot apex should be early in the season during active vegetative growth.

Sometimes there is a waxy layer covering the stem surface which gives a bluish or whitish appearance. The layer should be removed by rubbing before observing stem color.

Ad. 5: Stem: color

Assessed on side least exposed to sun. Sometimes there is a waxy layer covering the stem surface which gives a bluish or whitish appearance. The layer should be removed by rubbing before observing stem color.

Ad. 7: Leaf: type of division of blade

Leaf terminology

Division – A leaf blade that is dissected  $\frac{1}{4}$  or more to the midrib (primary division). Each segment may be further dissected to form a secondary division or, again, to form a tertiary division.

Lobe – a segment of a leaf division.



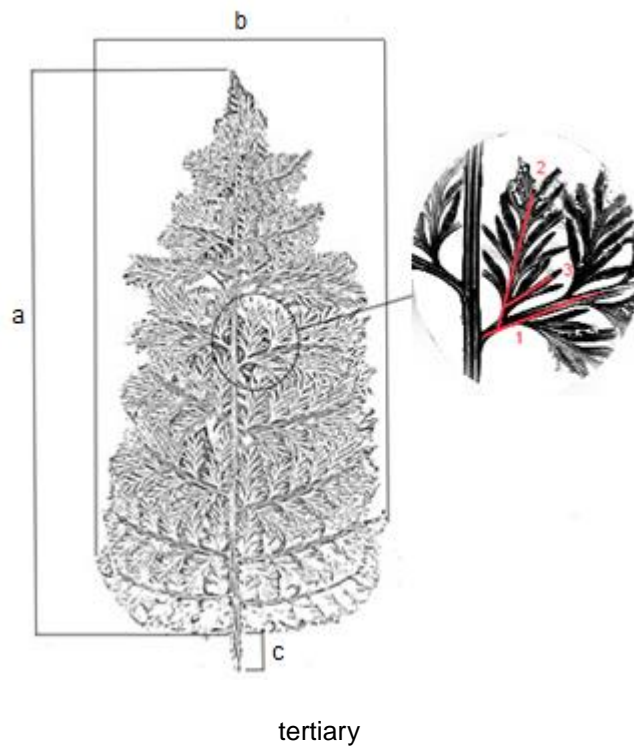
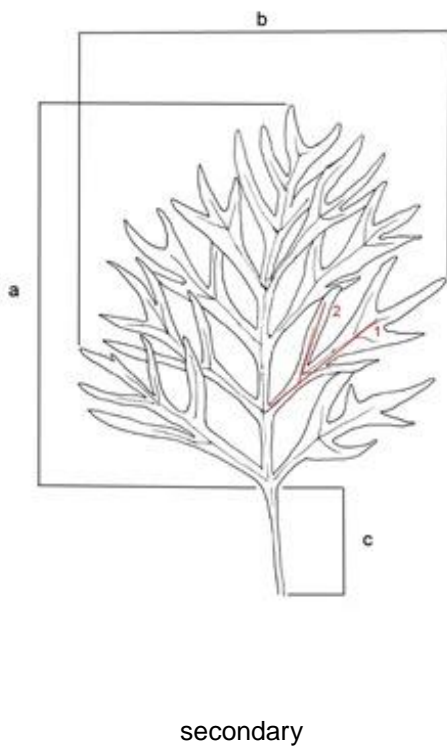
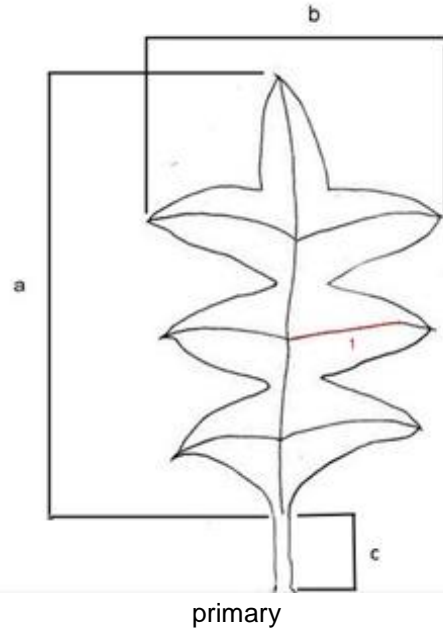
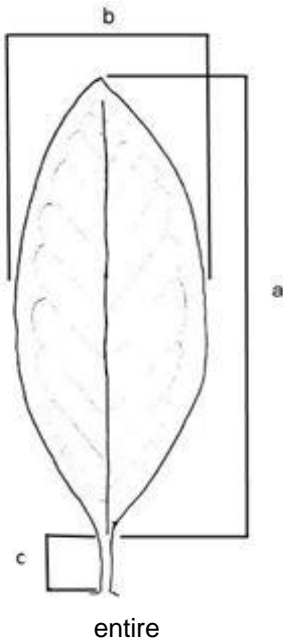





Sinus – the space between two segments of a leaf division.



a = leaf length of blade, observed excluding petiole  
b = leaf width of blade, observed at widest point  
c = petiole length

1 = primary division  
2 = secondary division  
3 = tertiary division

Ad. 8: Only varieties with Leaf: type of division of blade: entire: Leaf: blade shape

| width (ratio length/width) | ← broadest part →  |  |   |
|----------------------------|--|--|---|
|                            | below middle   | at middle  | above middle  |
| narrow (high)              |  | <br>7<br>linear     |   |
| medium (medium)            | <br>2<br>lanceolate | <br>6<br>oblong     |   |
|                            | <br>1<br>ovate     | <br>5<br>elliptic  | <br>8<br>obovate |
| broad (low)                |  | <br>3<br>circular | <br>4<br>rhombic |

Only observed on entire leaves.

Ad. 9: Only varieties with Leaf: type of division of blade: entire: Leaf: shape of apex

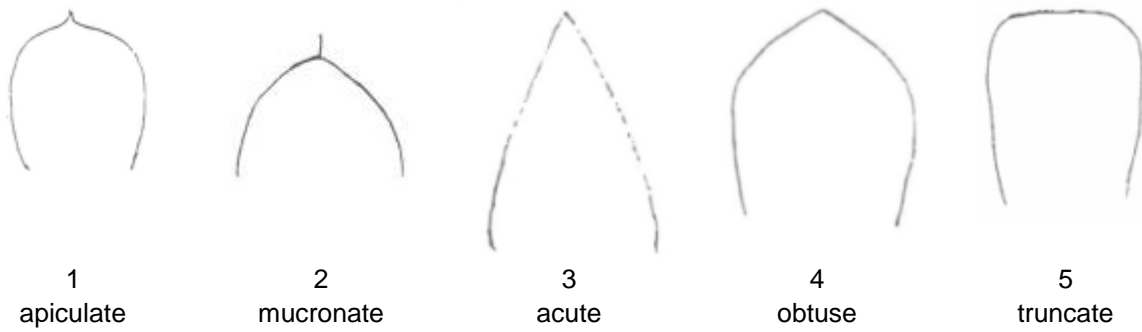

Ad. 11: Leaf: depth of sinus of primary division

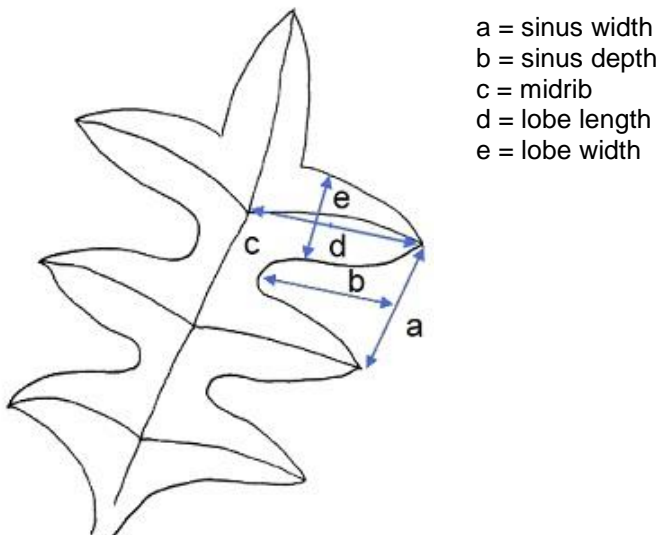

Ad. 12: Leaf: width of sinus of primary division

See Ad. 11

Observed, at widest point, on varieties with only primary division of blade present.

Ad. 13: Leaf: attitude of primary lobes in relation to midrib

Observed on lobes of primary division. Excluding secondary and tertiary divisions, if present.

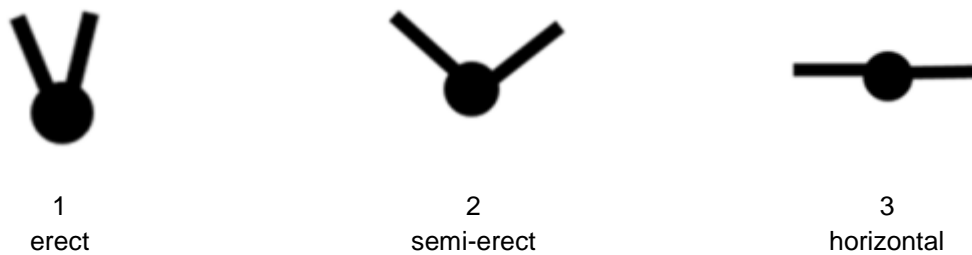

Ad. 14: Leaf: shape of apex of sinus of primary division

Observed on sinus immediately below leaf apex on primary division. Excluding secondary and tertiary divisions, if present.



1  
pointed



2  
rounded



3  
truncated

Ad. 15: Leaf: length of lobe of primary division

See Ad. 11

Observed on lobe immediately below leaf apex on primary division. Excluding secondary and tertiary divisions, if present.

Ad. 16: Leaf: width of lobe of primary division

See Ad. 11

Observed on lobe immediately below leaf apex on primary division. Excluding secondary and tertiary divisions, if present.

Ad. 17: Leaf: profile in cross section

To be observed on entire and primary leaf types only.



1  
flat or slightly recurved



2  
strongly recurved



3  
angularly revolute to the  
mid vein



4  
smoothly revolute to the  
mid vein

Ad. 19: Leaf: color of lower side

Overall appearance of color with hairs present.

Ad. 23: Leaf: length of petiole

See Ad. 7



Ad. 25: Inflorescence: attitude

Observed on natural position on plant.

Ad. 27: Inflorescence: length

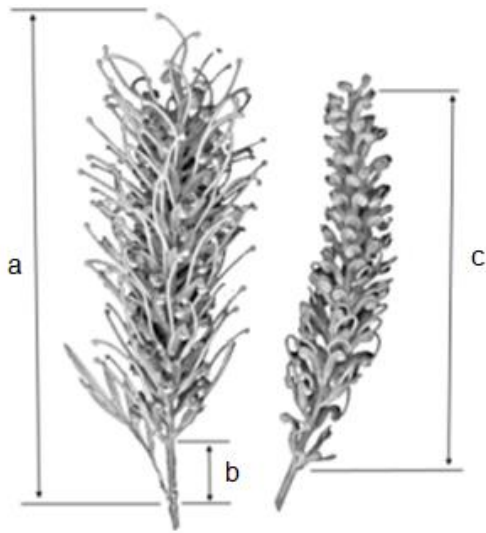

a = inflorescence  
b = peduncle  
c = rachis

Ad. 29: Inflorescence: type

Irregular type is a loose asymmetrical inflorescence

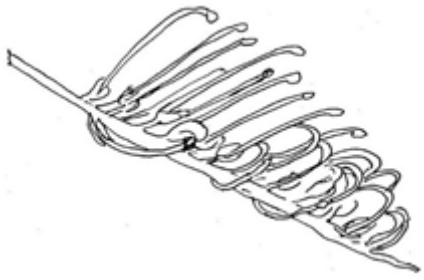

1  
secund



2  
irregular



3  
cylindric



4  
triangular



5  
umbellate



6  
ovoid



7  
domed

Ad. 30: Inflorescence: sequence of flower opening

Acropetal - flowers open sequentially towards the top of the inflorescence.

Basipetal - flowers open sequentially towards the base of the inflorescence.

Synchronous - flowers open approximately the same time across the length of the inflorescence.

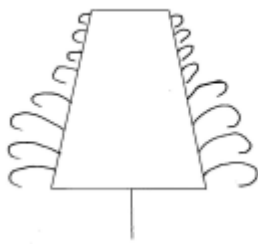

1  
acropetal

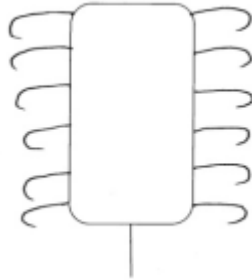

2  
synchronous

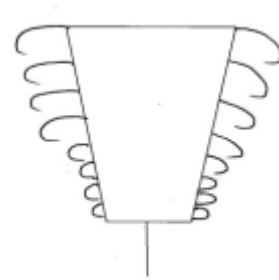

3  
basipetal

Ad. 35: Pedicel: attitude in relation to rachis



1  
leaning towards the apex



2  
perpendicular



3  
leaning towards the base

Ad. 37: Flower bud: attitude of limb in relation to longitudinal axis of bud

Observed during late bud prior to anthesis.

Ad. 42: Perianth: hairiness

Observed on the outer side of perianth and including limb.

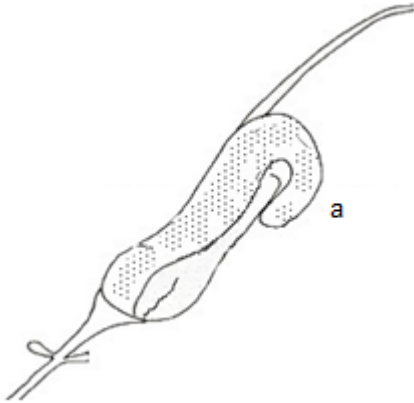

a = perianth limb

Ad. 44: Perianth: coherence of tepals on dorsal side

Observed as the length of tepal sticking (not fused) to the perianth.

Ad. 45: Perianth: coherence of tepals on ventral side

See Ad. 44

Ad. 46: Perianth: color

Observed on open flower.

Ad. 51: Style: curvature

Observed after anthesis before dehiscence of perianth.

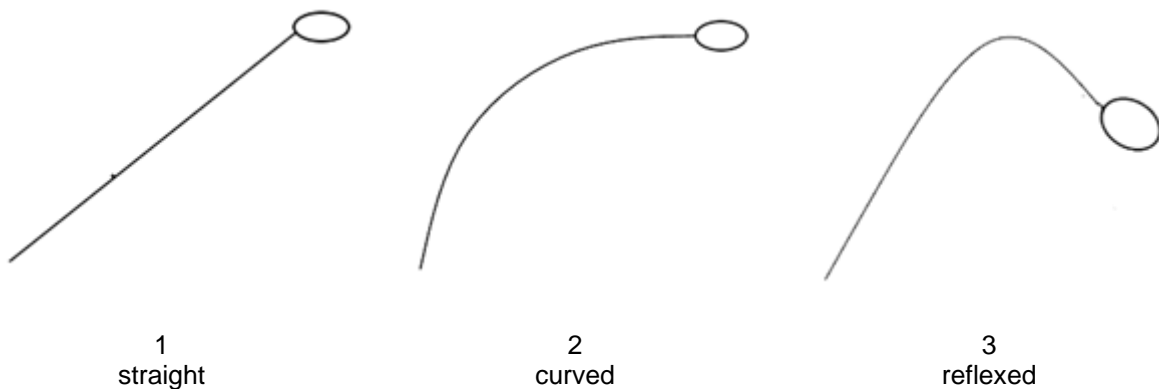

1  
straight

2  
curved

3  
reflexed

Ad. 56: Pollen presenter: attitude to style



1  
lateral

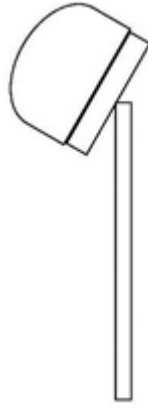

2  
oblique



3  
transverse

Ad. 57: Pollen presenter: shape



1  
domed



2  
flat



3  
conic



4  
cylindric

9. Literature

McGillivray, D. J., Makinson, R. O., 1993: Grevillea, Proteaceae: a taxonomic revision. Melbourne University Press at the Miegunyah Press, Carlton, Vic. AU, 465 pp.

10. Technical Questionnaire

|                         |                 |                   |
|-------------------------|-----------------|-------------------|
| TECHNICAL QUESTIONNAIRE | Page {x} of {y} | Reference Number: |
|-------------------------|-----------------|-------------------|

|  |   |
|--|---|
|  | Application date:<br>(not to be filled in by the applicant) |
|--|---|

TECHNICAL QUESTIONNAIRE  
to be completed in connection with an application for plant breeders' rights

1. Subject of the Technical Questionnaire

1.1 Botanical name

1.2 Common name

1.3 Species

2. Applicant

Name

Address

Telephone No.

Fax No.

E-mail address

Breeder (if different from applicant)

3. Proposed denomination and breeder's reference

Proposed denomination (if available)

Breeder's reference

#4. Information on the breeding scheme and propagation of the variety

4.1 Breeding scheme

Variety resulting from:

4.1.1 Crossing

(a) controlled cross [ ]  
(please state parent varieties)

(.....) x (.....)

female parent

male parent

(b) partially known cross [ ]  
(please state known parent variety(ies))

(.....) x (.....)

female parent

male parent

(c) unknown cross [ ]

4.1.2 Mutation [ ]  
(please state parent variety)

4.1.3 Discovery and development [ ]  
(please state where and when discovered and how developed)

4.1.4 Other [ ]  
(Please provide details)



|                         |                 |                   |
|-------------------------|-----------------|-------------------|
| TECHNICAL QUESTIONNAIRE | Page {x} of {y} | Reference Number: |
|-------------------------|-----------------|-------------------|

4.2 Method of propagating the variety

4.2.1 Vegetative propagation

- (a) Cuttings
- (b) *In vitro* propagation
- (c) Other (state method)

4.2.2 Other   
(Please provide details)

|                         |                 |                   |
|-------------------------|-----------------|-------------------|
| TECHNICAL QUESTIONNAIRE | Page {x} of {y} | Reference Number: |
|-------------------------|-----------------|-------------------|

5. Characteristics of the variety to be indicated (the number in brackets refers to the corresponding characteristic in Test Guidelines; please mark the note which best corresponds).

| Characteristics                                      | Example Varieties | Note  |
|--|-------------------|-------|
| <b>5.1 Plant: habit<br/>(1)</b>                      |                   |       |
| upright  | Callum's Gold     | 1 [ ] |
| semi upright   | Honey Gem         | 2 [ ] |
| spreading  | Ninderry-Sunrise  | 3 [ ] |
| prostrate  | Raptor            | 4 [ ] |
| <b>5.2 Inflorescence: type<br/>(29)</b>              |                   |       |
| secund   | Ninderry-Sunrise  | 1 [ ] |
| irregular  | LadyO             | 2 [ ] |
| cylindrical  | Callum's Gold     | 3 [ ] |
| triangular   | Fireworks         | 4 [ ] |
| umbellate  |                   | 5 [ ] |
| ovoid  |                   | 6 [ ] |
| domed  | H22               | 7 [ ] |
| <b>5.3 Inflorescence: predominant color<br/>(31)</b> |                   |       |
| white  | Ivory Whip        | 1 [ ] |
| green  |                   | 2 [ ] |
| yellow   | Callum's Gold     | 3 [ ] |
| orange   | Ninderry-Sunrise  | 4 [ ] |
| pink   | Blood Orange      | 5 [ ] |
| red  | Raptor            | 6 [ ] |
| <b>5.4 Perianth: color<br/>(46)</b>                  |                   |       |
| white  | Ivory Whip        | 1 [ ] |
| green  | Sandra Gordon     | 2 [ ] |
| yellow   | Callum's Gold     | 3 [ ] |
| orange   | Ninderry-Sunrise  | 4 [ ] |
| pink   | Blood Orange      | 5 [ ] |
| red  | Raptor            | 6 [ ] |

|                         |                 |                   |
|-------------------------|-----------------|-------------------|
| TECHNICAL QUESTIONNAIRE | Page {x} of {y} | Reference Number: |
|-------------------------|-----------------|-------------------|

6. Similar varieties and differences from these varieties

*Please use the following table and box for comments to provide information on how your candidate variety differs from the variety (or varieties) which, to the best of your knowledge, is (or are) most similar. This information may help the examination authority to conduct its examination of distinctness in a more efficient way.*

| Denomination(s) of variety(ies) similar to your candidate variety | Characteristic(s) in which your candidate variety differs from the similar variety(ies) | Describe the expression of the characteristic(s) for the <b>similar</b> variety(ies) | Describe the expression of the characteristic(s) for <b>your</b> candidate variety |
|---|---|--|--|
| <i>Example</i>  | <i>Plant: habit</i>   | <i>upright</i>   | <i>semi-upright</i>  |
|   |   |  |  |
|   |   |  |  |
| Comments:   |   |  |  |

|                         |                 |                   |
|-------------------------|-----------------|-------------------|
| TECHNICAL QUESTIONNAIRE | Page {x} of {y} | Reference Number: |
|-------------------------|-----------------|-------------------|

#7. Additional information which may help in the examination of the variety

7.1 In addition to the information provided in sections 5 and 6, are there any additional characteristics which may help to distinguish the variety?

Yes  No

(If yes, please provide details)

7.2 Are there any special conditions for growing the variety or conducting the examination?

Yes  No

(If yes, please provide details)

7.3 Other information

A representative color photograph of the variety displaying its main distinguishing feature(s), should accompany the Technical Questionnaire. The photograph will provide a visual illustration of the candidate variety which supplements the information provided in the Technical Questionnaire.

The key points to consider when taking a photograph of the candidate variety are:

- Indication of the date and geographic location
- Correct labeling (breeder's reference)
- Good quality printed photograph (minimum 10 cm x 15 cm) and/or sufficient resolution electronic format version (minimum 960 x 1280 pixels)"

Further guidance on providing photographs with the Technical Questionnaire is available in document TGP/7 "Development of Test Guidelines", Guidance Note 35 (<http://www.upov.int/tgp/en/>).

[The link provided may be deleted by members of the Union when developing authorities' own test guidelines.]

8. Authorization for release

(a) Does the variety require prior authorization for release under legislation concerning the protection of the environment, human and animal health?

Yes [ ] No [ ]

(b) Has such authorization been obtained?

Yes [ ] No [ ]

If the answer to (b) is yes, please attach a copy of the authorization.

9. Information on plant material to be examined or submitted for examination

9.1 The expression of a characteristic or several characteristics of a variety may be affected by factors, such as pests and disease, chemical treatment (e.g. growth retardants or pesticides), effects of tissue culture, different rootstocks, scions taken from different growth phases of a tree, etc.

9.2 The plant material should not have undergone any treatment which would affect the expression of the characteristics of the variety, unless the competent authorities allow or request such treatment. If the plant material has undergone such treatment, full details of the treatment must be given. In this respect, please indicate below, to the best of your knowledge, if the plant material to be examined has been subjected to:

- |     |   |         |        |
|-----|---|---------|--------|
| (a) | Microorganisms (e.g. virus, bacteria, phytoplasma)    | Yes [ ] | No [ ] |
| (b) | Chemical treatment (e.g. growth retardant, pesticide) | Yes [ ] | No [ ] |
| (c) | Tissue culture  | Yes [ ] | No [ ] |
| (d) | Other factors   | Yes [ ] | No [ ] |

Please provide details for where you have indicated "yes".

.....

10. I hereby declare that, to the best of my knowledge, the information provided in this form is correct:

Applicant's name

Signature

Date

[End of document]